

Article number: 20111030

Description: E+G Revolving handle
DIN 98-AL-32-E

Measures

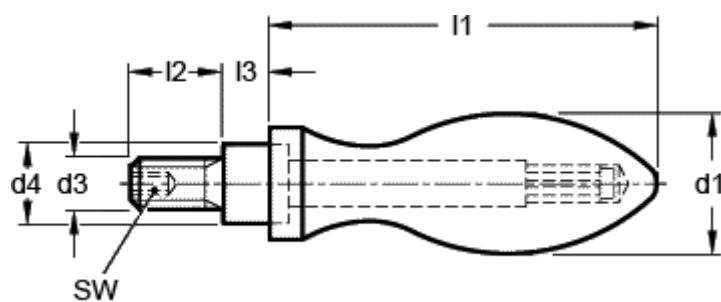

d1	= 32
d3	= M12
d4 h13	= 20
l1 approx.	= 95
l2	= 21
l3	= 10.5
SW	= 6